

Float Switch, model **S12, S18, S48, SS12, SS18, SP12, SP20, F50, F70**
FLS-SAF, ELS-SAF

EN



S12

Stainless steel version, flanged

**Operating Instructions, Model S12, S18, S48, SS12, SS18,
SP12, SP20, F50, F70
FLS-SAF, ELS-SAF**

© 2016 WIKA Alexander Wiegand SE & Co. KG

All rights reserved. / Alle Rechte vorbehalten.

WIKA® and KSR® are registered trademarks in various countries.

WIKA® and KSR® sind geschützte Marken in verschiedenen Ländern.

Prior to starting any work, read the operating instructions!

Keep for later use!

Vor Beginn aller Arbeiten Betriebsanleitung lesen!

Zum späteren Gebrauch aufbewahren!

**KSR Kuebler Niveau-Messtechnik GmbH**

Heinrich-Kuebler-Platz 1

69439 Zwingenberg am Neckar • Germany

Tel. +49 6263/87-0

Fax +49 6263/87-99

info@ksr-kuebler.com

www.ksr-kuebler.com

**Gayesco-WIKA USA**

229 Beltway Green Boulevard

Pasadena, Texas 77503

Tel. +1 713 475 0022

Fax +1 713 475 0011

info@wikahouston.com

www.wika.com

Contents

1. General information	4
2. Design and function	5
3. Safety	6
4. Transport, packaging and storage	10
5. Commissioning, operation	10
6. Faults	19
7. Maintenance and cleaning	20
8. Dismounting, return and disposal	22
9. Specifications	23

1. General information

- The float switches described in the operating instructions have been designed and manufactured using state-of-the-art technology. All components are subject to stringent quality and environmental criteria during production. Our management systems are certified to ISO 9001.
- These operating instructions contain important information on handling the instrument. Working safely requires that all safety instructions and work instructions are observed.
- Observe the relevant local accident prevention regulations and general safety regulations for the instrument's range of use.
- The operating instructions are part of the product and must be kept in the immediate vicinity of the instrument and readily accessible to skilled personnel at any time. Pass the operating instructions on to the next operator or owner of the instrument.
- Skilled personnel must have carefully read and understood the operating instructions prior to beginning any work.
- The general terms and conditions contained in the sales documentation shall apply.
- Subject to technical modifications.
- Further information:

Internet address: www.ksr-kuebler.com / www.wika.com

Relevant data sheet: FLS / LM 30.01

Abbreviations, definitions

L-SP Level switch point

T-SP Temperature switch point

NO/NC Normally open/normally closed

CO Change-over

2. Design and function

2.1 Functional description

Float switches work on the float principle with magnetic transmission. A reed contact integrated in the guide tube is actuated through the magnetic field of a permanent magnet, when a preset switch point is reached. The permanent magnet is located within a float, which changes its height with the level of the medium it is monitoring. The switching status of the reed contact can be evaluated and processed by a connected control device.

The number and arrangement of floats is dependent on the number of the defined switch points, their contact function and also the distance between the switch points.

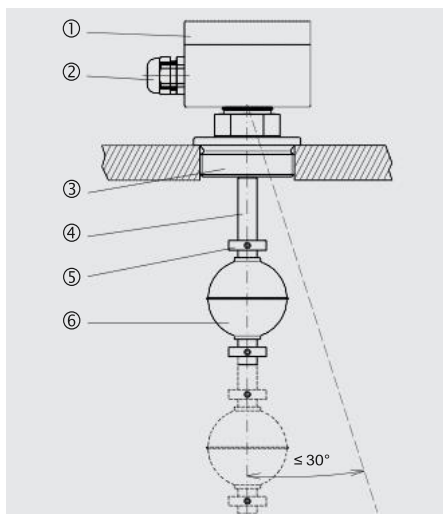

1 Connection housing

2 Cable bushing

3 Mounting thread

4 Guide tube

5 Float stop

6 Float

2.2 Scope of delivery

Cross-check scope of delivery with delivery note

3. Safety

3.1 Symbols



DANGER!

... indicates an immediately hazardous situation which might result in death or severe injuries if it is not avoided.



WARNING!

... indicates a potentially hazardous situation which might result in death or severe injuries if it is not avoided.



CAUTION!

... indicates a potentially hazardous situation which might result in light or minor injuries or property or environmental damages if it is not avoided.



Installation, electrotechnical expertise!

For the installation particular electrotechnical expertise is required.



Installation, mechanical expertise!

For the installation particular mechanical expertise is required.



Information

... highlights useful tips and recommendations and information for efficient and fault-free operation.

3.2 Proper intended use

Float switches are solely intended for monitoring the liquid level of fluids. The area of use is based on the technical performance limits and materials.

- The fluids must not be contaminated nor contain coarse particles nor tend to crystallize. It must be ensured that the magnetic switch materials that come into contact with the media are sufficiently resistant to the

monitored medium. Not suitable for dispersion, abrasive fluids, highly viscous media and paints.

- Compliance with the usage conditions specified in the operating instructions is required.
- Do not operate the unit in direct proximity of ferro-magnetic environments (distance min. 50mm).
- Do not operate the unit in direct proximity of strong electromagnetic fields or in direct proximity of facilities that can be impacted by magnetic fields (distance min. 1m).
- Float switches may not be subjected to strong mechanical stresses (impact, bending, vibrations). The unit is exclusively designed and constructed for the intended use described here and may only be used accordingly.
- The switching points of the float switch cannot be adjusted.
- Compliance with the relevant safety regulations for the use is required.
- Compliance with the technical specifications in these operating instructions is required. Improper use or operation of the unit outside the technical specifications requires immediate shut-down and inspection by an authorized KSR or WIKA service technician.

Claims of any kind due to improper use are excluded.



DANGER!

When working on containers, there is a risk of poisoning or suffocation. Work may only be performed using suitable personal safety equipment (e.g. respiratory protection, protective clothing, etc.).

An explosive atmosphere may develop in a container. Measures must be taken to prevent sparking. Work in such areas must be done by qualified personnel in accordance with the relevant safety regulations and guidelines.

3.3 Improper use

Any use that exceeds the technical performance thresholds or that is incompatible with the materials is considered improper use.



WARNING!

Injury due to improper use

Improper use of the unit can result in hazardous situations and injuries.

Do not modify the unit without authorization

Any use beyond the proper intended use or any other use is considered improper use.

Do not use this unit in safety or emergency off equipment.

3.4 Responsibility of the operator

The unit is used in the industrial sector. The operator is therefore subject to statutory obligations with respect to occupational safety.

Compliance with the safety instructions in these operating instructions and the applicable safety, accident prevention and environmental protection regulations for the area of use of the unit is required.

In order to safely work on the unit, the operator must ensure

- the operating personnel is regularly trained in all matters pertaining to occupational safety, first aid and environmental conservation and is familiar with the operating instructions and, in particular, the safety instructions contained therein
- the unit is suitable for the application in accordance with the proper intended use (check for improper use).

After check, improper use is excluded.

3.5 Personnel qualification



WARNING!

Risk of injury due to insufficient qualifications

Improper use can result in significant personal injury and property damages.

- The activities described in these operating instructions may only be performed by specialist technicians with the following qualifications.

Specialist personnel

The specialist personnel authorized by the operator is capable of executing the described work and autonomously detect potential hazards due their technical training, knowledge of measuring and control technology and their experience and knowledge of country-specific regulations, applicable standards and guidelines.

3.6 Personal safety equipment

The personal safety equipment serves to protect the technicians against hazards that might impact the safety or health while working. When executing the various tasks on and with the unit, the technicians must wear personal safety equipment.

Comply with warning signs posted in the work area regarding personal safety equipment!

The required personal safety equipment must be provided by the operator.

4. Transport, packaging and storage

4.1 Transport

Check the float switch for any damage that may have been caused by transport. Obvious damage must be reported immediately.



CAUTION!

Damage due to improper transport

With improper transport, a high level of damage to property can occur.

- Observe the symbols on the packaging.
- Handle packed goods with care

4.2 Transport and storage

Do not remove packaging until just before commissioning.

5. Commissioning, operation

- Observe all instructions given on the shipment packaging for removing the transportation safety devices.
- Remove the float switch carefully from the packaging!
- When unpacking, check all components for any external damage.

5.1 Mounting preparations



Functional check

Before mounting, the float switch can be connected as described in chapter 5.3 and the switch points can be operated manually.



WARNING!

Ensure that the functional check does not start any unintended processes.

Functional tests must only be carried out with equipment that is approved for use in hazardous area. Tests must be conducted by qualified personnel in accordance with the relevant safety regulations and guidelines.

Ensure that the sealing faces of the vessel or float switch are clean and do not show any mechanical damage.

5.2 Mounting

- Observe the torque values of screws specified in pipefitting work.
- In the selection of the mounting material (seals, bolts, washers and nuts), take the process conditions into account. The suitability of the sealing must be specified with regard to the medium and its vapours. In addition, ensure it has corresponding corrosion resistance.
- Mount the float switch either via mounting thread (3) or mounting flange (not illustrated).
- The guide tube (4) should not be inclined more than a maximum of 30° to the vertical.
- The number of floats and also the position of the float stops are dependent upon the dimension and the number of switch points.

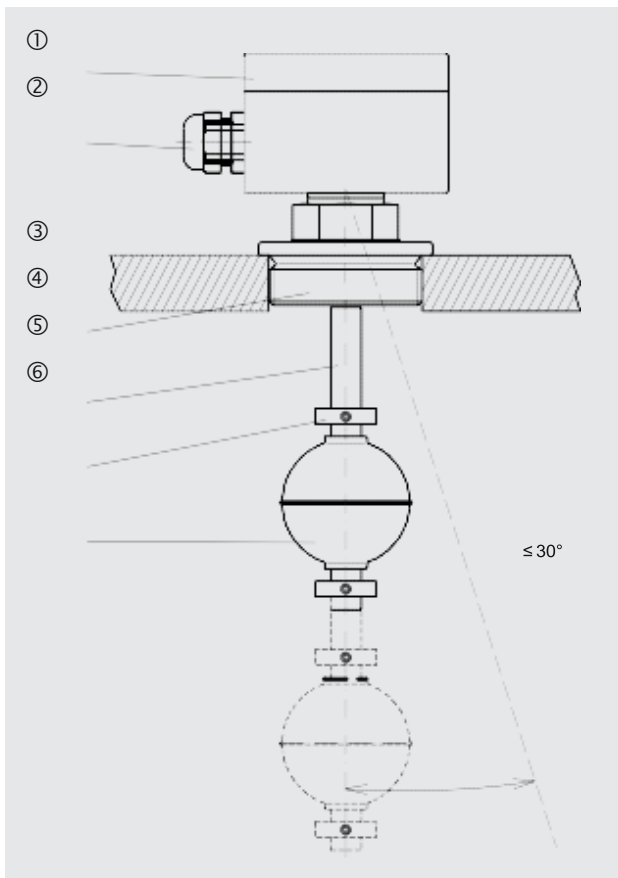

5.3 Electrical connection

- The electrical connection must only be made by qualified skilled personnel.
- Connection details and switching functions are given on the connection diagram on the instrument and the connection terminals are appropriately marked (exception: versions with only one normally closed or normally open contact).
- Seal the cable gland at the connection housing.

- All wiring and hardware must be in accordance with applicable standards and regulations. KSR Kuebler float switches are designed for pilot service or connection to a PLC. They should not be used to directly switch heavy loads as contact damage resulting in failure can occur.
- Install a pour-seal (conduit seal) fitting within 18 inches of the housing to prevent water from entering the housing and for compliance with the National Electrical Code.
- Wire sizing must be determined by the run length with a maximum size of 14 AWG. A ground wire must be provided and connected to the ground block inside the housing



WARNING!

Electrical connection errors of the float switches can destroy the reed contacts. This can lead to a malfunction in the plant and thus lead to injury to personnel or damage to equipment.

- No direct operation in circuits with inductive loads.
- No direct operation in circuits with capacitive loads, e.g. PLC, PCS or cable lengths > 50 m.
- Do not exceed the permissible switching power.

Connection with inductive load

With inductive loads, the float switches should be protected by connection to an RC element (snubber) or a free-wheeling diode.

AC voltage

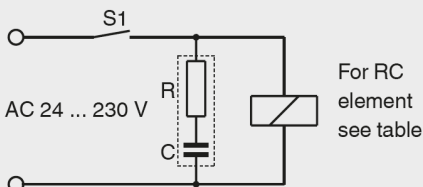

DC voltage

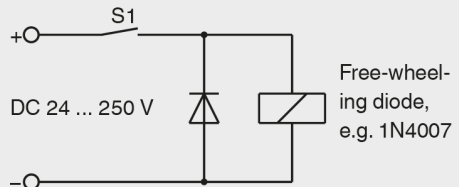

Protective RC elements

Depending on the operating voltage, use RC elements exclusively in accordance with the table below. RC elements other than those specified here will lead to the destruction of the reed switch.

RC elements for reed contacts 10 ... 40 VA

Voltage	Resistance	Capacitance	Type of RC element
AC 24 V	100 Ω	0.33 μF	A 3/24
AC 48 V	220 Ω	0.33 μF	A 3/48
AC 115 V	470 Ω	0.33 μF	A 3/115
AC 230 V	1,500 Ω	0.33 μF	A 3/230

RC elements for reed contacts 40 ... 100 VA

Voltage	Resistance	Capacitance	Type of RC element
AC 24 V	47 Ω	0.33 μF	B 3/24
AC 48 V	100 Ω	0.33 μF	B 3/48
AC 115 V	470 Ω	0.33 μF	B 3/115
AC 230 V	1,000 Ω	0.33 μF	B 3/230

Connection with conductive load

Capacitive load

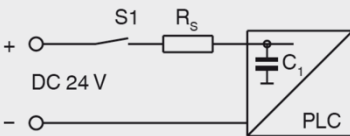

Electronic timers

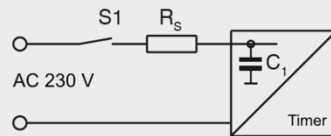

To increase the service life of the contacts, we recommend operation with a contact protection relay.

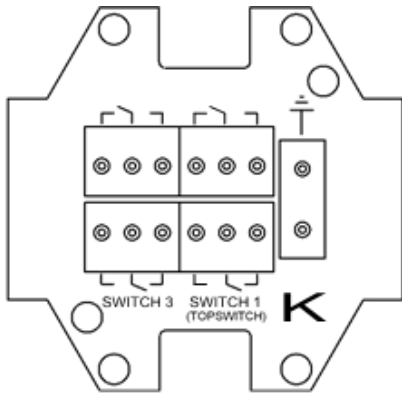

1 to 4 switch PCB

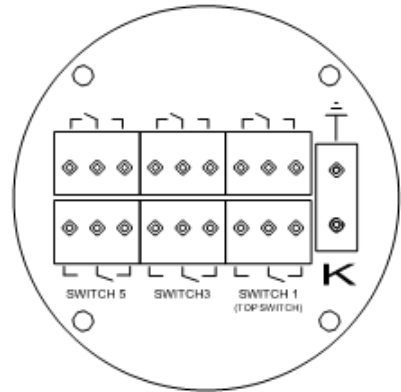

























































































































5 and 6 switch PCB

The symbols screened on the terminal block board show the connections to the terminal blocks (Figure 1). Note that the upper switch in the guide tube (nearest the flange) is numbered switch 1 and labeled “top switch” on the pc board. All other switches count consecutively downward.

Connections diagrams

Color coding per IEC 757

Number of switch points	PVC cable		Silicone cable		Connection housing	
	NO/NC	CO	NO/NC	CO	NO/NC	CO
1 L-SP	GY  L1 BK  L1	GY  L1 BN  L1 BK  L1	GY  L1 BK  L1	GY  L1 BN  L1 BK  L1	GY 1  L1 BN 2  L1	GY 1  L1 BN 2  L1 BK 3  L1
2 L-SP	BK  L1 BK  L1 BN  L2 GY  L2	YE  L1 GN  L1 BK  L2 BU  L2 PK  L2 GY  L2	BK  L1 BK  L1 BN  L2 GY  L2	YE  L1 GN  L1 BK  L2 BU  L2 RD  L2 WH  L2	BK 1  L1 BK 2  L1 BN 3  L2 GY 4  L2	YE 1  L1 GN 2  L1 BN 3  L2 GY 4  L2 RD 5  L2 WH 6  L2
3 L-SP	GN  L1 BN  L1 YE  L2 GY  L2 PK  L3 BU  L3	BU-RD  L1 RD  L1 WH  L1 YE  L2 GN  L2 BN  L2 BU  L3 PK  L3 GY  L3	GN  L1 BN  L1 YE  L2 GY  L2 PK  L3 BU  L3	-	BN 1  L1 WH 2  L1 YE 3  L2 GN 4  L2 GY 5  L3 RD 6  L3	WH 1  L1 BK 2  L1 OG 3  L1 YE 4  L2 GN 5  L2 BN 6  L2 BU 7  L3 PK 8  L3 GY 9  L3
4 L-SP	RD  L1 WH  L1 GN  L2 BN  L2 YE  L3 GY  L3 PK  L4 BU  L4	GY-RD  L1 BK  L1 VT  L1 BU-RD  L2 RD  L2 WH  L2 YE  L3 GN  L3 BN  L3 BU  L4 PK  L4 GY  L4	-	-	RD 1  L1 WH 2  L1 GN 3  L2 BN 4  L2 YE 5  L3 GY 6  L3 PK 7  L4 BU 8  L4	WH 1  L1 BK 2  L1 OG 3  L1 YE 4  L2 GN 5  L2 BN 6  L2 BU 7  L3 PK 8  L3 GY 9  L3 RD 10  L4 VT 11  L4 CLEAR 12  L4

5.4 Commissioning

Switch on the voltage supply of the connected control device. Fill the vessel and check the switch points of the float switch for function.



WARNING!

Ensure that the functional check does not start any unintended processes.

Always observe the mounting and operating instructions of accessories when commissioning them.

6. Faults



The following table contains the most frequent causes of faults and the necessary countermeasures.

Faults	Causes	Measures
Float switch cannot be mounted at the planned place on the vessel	Process connection of the float switch does not match the process connection of the vessel.	Modification of the vessel Return to the factory
	Process connection at the vessel defective	Rework the thread or replace the screwed coupling
	Mounting thread at the float switch defective	Return to the factory
No or undefined switching function	Electrical connection incorrect	See chapter 5.3 “Electrical connection”. Check assignment with the aid of the connection diagram.
	Temperature contact defective	Return to the factory
	Reed contact defective	Return to the factory



CAUTION!

Physical injuries and damage to property and the environment

If faults cannot be eliminated by means of the listed measures, the instrument must be taken out of operation immediately.

- Ensure that there is no longer any pressure present and protect against being put into operation accidentally.
- Contact the manufacturer.
- If a return is needed, please follow the instructions given in chapter 8.2 “Return”.

7. Maintenance and cleaning

7.1 Maintenance

When used properly, the float switches work maintenance-free. They must be subjected to visual inspection within the context of regular maintenance, however, and included in the vessel pressure test.



DANGER!

Work on vessels involves the danger of intoxication and suffocation. No work is allowed to be carried out unless by taking suitable personal protective measures (e.g. respiratory protection apparatus, protective outfit etc.).

Repairs must only be carried out by the manufacturer.



Perfect functioning of the float switches can only be guaranteed when original accessories and spare parts are used.

7.2 Cleaning



CAUTION!

Physical injuries and damage to property and the environment

Improper cleaning may lead to physical injuries and damage to property and the environment. Residual media in the dismantled instrument can result in a risk to persons, the environment and equipment.

- Rinse or clean the removed instrument.
- Sufficient precautionary measures must be taken.

1. Prior to cleaning the unit, properly disconnect it from the process and the power supply.
2. Carefully clean the unit with a damp cloth.
3. Do not let electrical connections come into contact with moisture!



CAUTION!

Damage to property

Improper cleaning may lead to damage to the instrument!

- Do not use any aggressive cleaning agents.
- Do not use any pointed and hard objects for cleaning.

8. Dismounting, return and disposal



WARNING!

Physical injuries and damage to property and the environment through residual media

Residual media in the dismantled instrument can result in a risk to persons, the environment and equipment.

- Wash or clean the dismantled instrument, in order to protect persons and the environment from exposure to residual media.

8.1 Dismounting

Only disconnect the measuring instrument once the system has been de-pressurised and the power disconnected!

8.2 Return

Wash or clean the dismantled float switch before returning it, in order to protect personnel and the environment from exposure to residual media.



Information on returns can be found under the heading “Service” on our local website.

8.3 Disposal

Incorrect disposal can put the environment at risk.

Dispose of instrument components and packaging materials in an environmentally compatible way and in accordance with the country-specific waste disposal regulations.

9. Specifications

Models

Model	Description
S12	Float switch with guide tube OD 12 mm
S18	Float switch with guide tube OD 18 mm
S48	Float switch with guide tube OD 48 mm
SS14	Float switch with guide tube OD 14 mm, sanitary design
SS18	Float switch with guide tube OD 18 mm, sanitary design
SP12	Float switch with guide tube OD 12 mm, plastic design
SP20	Float switch with guide tube OD 20 mm, plastic design
F50	Chambered float switch with chamber OD 70 mm
F70	Chambered float switch with chamber OD 60 mm
FLS-SAF	Float switch with guide tube OD 12 or 18 mm
ELS-SAF	Chambered float switch with chamber OD 60 mm

Switch rating

Model	Normally open, normally closed	Change-over
all	max. AC 230 V; 100 VA; 1 A max. DC 230 V; 50 W; 0.5 A	max. AC 230 V; 40 VA; 1 A max. DC 230 V; 20 W; 0.5 A

Marking

Model	Rating ^{*)}	Marking
S12 S18 S48 SS14 SS18 FLS-SAF	XP DIP	XP / I / 1 / BCD / T6 Ta = 77°C, DIP / II,III / 1 / EFG / T6 Ta = 77°C; Type 4, 4X
F50 F70 ELS-SAF	XP DIP	XP / I / 1 / BCD / T6 Ta = 77°C, DIP / II,III / 1 / EFG / T6 Ta = 77°C; Type 4

***) Ratings (FM-approved for the United States of America)**

XP: Explosionproof for Class I, Division 1, Groups B, C and D

DIP: Dust-ignitionproof for Class II/III, Division 1, Groups E, F and G

Type code S, SS, SP

Field-No.	Code	Description								
Basic type										
1	S	Standard design								
	SS	Sanitary design								
	SP	Plastic design								
OD Guide tube										
2	nn	OD Guide tube in mm (2 digits)								
Number of switches										
3	a	1 to 4								
Material of construction (wetted parts)										
4	b	<table> <tr> <td>S = SS 316Ti</td> <td>L = SS 316L</td> </tr> <tr> <td>C = Hastelloy C</td> <td>B = Hastelloy B</td> </tr> <tr> <td>T = Titanium</td> <td>V = PVC</td> </tr> <tr> <td>P = PP</td> <td>K = Kynar (PVDF)</td> </tr> </table>	S = SS 316Ti	L = SS 316L	C = Hastelloy C	B = Hastelloy B	T = Titanium	V = PVC	P = PP	K = Kynar (PVDF)
S = SS 316Ti	L = SS 316L									
C = Hastelloy C	B = Hastelloy B									
T = Titanium	V = PVC									
P = PP	K = Kynar (PVDF)									
Length										
5	ccc	Length in full inches (3 digits)								
Connection size and type										
6	ddd	NPT thread								
		N05 = 1/2 NPT								
		N10 = 1 NPT								
		N20 = 2 NPT								
		N75 = 3/4 NPT								
		N15 = 1.5 NPT								
		NAD = 1/2 NPT adjustable								
		Flange ASME B16.5								
		F10 = 1"								
		F20 = 2"								
		F30 = 3"								
		F50 = 5"								
F15 = 1.5"										
F25 = 2.5"										
F40 = 4"										
F60 = 6"										
BSP thread										
G05 = BSP 1/2										
G10 = BSP 1										
G20 = BSP 2										
G75 = BSP 3/4										
G15 = BSP 1.5										

Field-No.	Code	Description
Connection rating		
7	e	A = Flange Class 150 B = Flange Class 300 C = Flange Class 600 D = Thread
Electrical housing		
8	f	4 = Aluminium 7 = Aluminium XP 8 = Stainless steel XP
Switch temperature rating		
9	g	S = -40°C to +148°C (-40°F to +300°F) L = -184°C to +148°C (-300°F to +300°F) H = -40°C to +343°C (-40°F to +650°F)

Type code F

Field-No.	Code	Description
Basic type		
1	F50	Chamber OD 70 mm
	F70	Chamber OD 60 mm (NS 2")
Number of switches		
2	a	1 to 4
Material of construction (wetted parts)		
3	b	S = SS 316Ti L = SS 316L C = Hastelloy C B = Hastelloy B T = Titanium
Chamber construction class		
4	c	A = Class 150 B = Class 300 K = KSR commercial design
Connection size and type		
5	ddd	NPT thread N05 = 1/2 NPT N75 = 3/4 NPT N10 = 1 NPT NAD = 1/2 NPT adjustable
		Flange ASME B16.5 F10 = 1" F15 = 1.5" F20 = 2" F25 = 2.5" F30 = 3" F40 = 4" F50 = 5" F60 = 6"
		BSP thread G05 = BSP 1/2 G75 = BSP 3/4 G10 = BSP 1
Connection rating		
6	e	A = Flange Class 150 B = Flange Class 300 C = Flange Class 600 D = Thread
Electrical housing		
8	f	4 = Aluminium 7 = Aluminium XP 8 = Stainless steel XP
Float selection		
9	g	S = Stainless steel S.G. 0.72 T = Titanium S.G. 0.67

Type code FLS

Field-No.	Code	Description
Basic type		
1	FLS	Float switch
Material of construction (wetted parts)		
2	S	Metal SS 316Ti, SS 316L, Titanium Hastelloy C, Hastelloy B
Electrical connection		
3	A	Housing with terminals
Approval		
4	F	XP, DIP

Type code ELS

Field-No.	Code	Description
Basic type		
1	ELS	Chambered float switch
Material of construction (wetted parts)		
2	S	Metal SS 316Ti, SS 316L, Titanium Hastelloy C, Hastelloy B
Electrical connection		
3	A	Housing with terminals
Approval		
4	F	XP, DIP

CERTIFICATE OF CONFORMITY



- HAZARDOUS (CLASSIFIED) LOCATION ELECTRICAL EQUIPMENT PER US REQUIREMENTS
- Certificate No: **FM18US0215**
- Equipment:
(Type Reference and Name) **Series F, MMS, MRS, S, SS, ELS-SAF, BGU-AXPF, BGU-AMXPF, BGU-AHTXPF, FLS-SAF Level Switch and Series BT, HT, ST, T, TD, TP, HTP, BLR-SBF, FLR-SBF Level Transmitter**
- Name of Listing Company: **KSR Kuebler Niveau-Messtechnik GmbH**
- Address of Listing Company: **Heinrich-Kuebler-Platz 1,
D-69439 Zwingenberg,
Germany**
- The examination and test results are recorded in confidential report number:
3D4A0.AE dated 8th March 1999
- FM Approvals LLC, certifies that the equipment described has been found to comply with the following Approval standards and other documents:
**FM Class 3600:2018, FM Class 3611 2004, FM Class 3615:2018, FM Class 3810: 2018,
NEMA 250:1991**
- If the sign 'X' is placed after the certificate number, it indicates that the equipment is subject to specific conditions of use specified in the schedule to this certificate.
- This certificate relates to the design, examination and testing of the products specified herein. The FM Approvals surveillance audit program has further determined that the manufacturing processes and quality control procedures in place are satisfactory to manufacture the product as examined, tested and Approved.
- Equipment Ratings:
Explosionproof for Class I, Division 1, Groups B, C and D; Dust-ignitionproof for Class II/III, Division 1, Groups E, F and G; Nonincendive for Class I, Division 2 Groups A, B, C and D hazardous (classified) locations, indoors and outdoors (Type 4, 4X)

Certificate issued by:

J.E. Marquedant
VP, Manager - Electrical Systems

26 January 2021

Date

To verify the availability of the Approved product, please refer to www.approvalguide.com

THIS CERTIFICATE MAY ONLY BE REPRODUCED IN ITS ENTIRETY AND WITHOUT CHANGE

FM Approvals LLC, 1151 Boston-Providence Turnpike, Norwood, MA 02062 USA
T: +1 (1) 781 762 4300 F: +1 (1) 781 762 9375 E-mail: information@fmapprovals.com www.fmapprovals.com

SCHEDULE



US Certificate Of Conformity No: FM18US0215

11. The marking of the equipment shall include:

BT-a-b, Level Transmitter.

CL I, Div 2, GP ABCD, T4 Ta = 60°C, Type 4

BTX-a-b, BTXi-a-b, BLR-SBF Level Transmitter.

CL I, Div 1, GP BCD T6 Ta = 60°C;

CL II, III, Div 1, GP EFG T3C Ta = 60°C;

CL I, Div 2, GP ABCD, T4 Ta = 60°C, Type 4

HT12abcdeffg, Level Transmitter.

HT14abcdeffg, HT18abcdeffg, Level Transmitter.

HTD14abcdeffg, HTD18abcdeffg, Level Transmitter.

ST14abcdeffgh, ST18abcdeffgh, Level Transmitter.

T12abcdeffg, Level Transmitter.T14abcdeffg, T18abcdeffg, Level Transmitter.T48abcdeffg0, Level Transmitter.

TD14abcdeffg, TD18abcdeffg, Level Transmitter.

TD48abcdeffg0, Level Transmitter.

FLR-SBF, Level Transmitter.

CL I, Div 1, GP BCD T6 Ta = 60°C;

CL II, III, Div 1, GP EFG T6 Ta = 60°C;

CL I, Div 2, GP ABCD, T4 Ta = 60°C, Type 4/4X

TP16abcdeffg, TP20abcdeffg, Level Transmitter.

CL I, Div 2, GP ABCD, T4 Ta = 60°C, Type 4/4X

F50abcdeffg, F70abcdeffg or ELS-SAF Level Switch.

CL I, Div 1, GP BCD T6 Ta = 77°C;

CL II, III, Div 1, GP EFG, Type 4

S12abcdeffg, Level Switch.

S18abcdeffg, Level Switch.

S48abcdeffg, Level Switch.

SS14abcdeffgh, Level Switch.

SS18abcdeffgh, Level Switch.

FLS-SAF, Level Switch.

CL I, Div 1, GP BCD T6 Ta = 77°C;

CL II, III, Div 1, GP EFG, T6 Ta = 77°C, Type 4/4X

SP12abcdeffgS and SP20abcdeffgS, Level Switch.

Type 4/4X

MRS-2-XP, MMS-5-XP, Level Switch.

MRS-2-XP-HT, Level Switch.

BGU-AMXPF, BGU-AXPF or BGU-AHTXPF, Level Switch.

Type 4

12. Description of Equipment:

General – Model F, MMS, MRS, S, SS, ELS-SAF, BGU-AXPF, BGU-AMXPF, BGU-AHTXPF, FLS-SAF Level Switches, and BT, HT, ST, T, TD, TP, HTP, BLR-SBF, FLR-SBF Level Transmitters measure the level of a liquid using a magnetically coupled float.

Construction – Model F, MMS, MRS, S, SS, ELS-SAF, BGU-AXPF, BGU-AMXPF, BGU-AHTXPF, FLS-SAF

THIS CERTIFICATE MAY ONLY BE REPRODUCED IN ITS ENTIRETY AND WITHOUT CHANGE

FM Approvals LLC, 1151 Boston-Providence Turnpike, Norwood, MA 02062 USA

T: +1 (1) 781 762 4300 F: +1 (1) 781 762 9375 E-mail: information@fmaprovals.com www.fmaprovals.com

F 347 (Mar 16)

Page 2 of 7

SCHEDULE



US Certificate Of Conformity No: FM18US0215

Level Switches, and BT, HT, ST, T, TD, TP, HTP, BLR-SBF, FLR-SBF Level Transmitters are coupled to a sensing tube probe assembly. The probe assembly is threaded into an electronics housing where all input/Output connections are made.

Ratings – See section 11 for the ambient temperature specifics of the Model F, MMS, MRS, S, SS, ELS-SAF, BGU-AXPF, BGU-AMXPF, BGU-AHTXPF, FLS-SAF Level Switches, and BT, HT, ST, T, TD, TP, HTP, BLR-SBF, FLR-SBF Level Transmitters.

BT-a-b. Level Transmitter.

- a = Resolution in mm (2 digits).
- b = Length in inches (4 digits).

BTX-a-b, BTXI-a-b. Level Transmitter.

- a = Resolution in mm (2 digits).
- b = Length in inches (4 digits).

BLR-ab. Level Transmitter.

- a = S, Standard (Metal housing)
- b = B, with head-mounted transmitter

HT12abcdefg. Level Transmitter.

- a = Resolution A, D or F.
- b = Wetted parts material S, L, B, C or T.
- c = Sensor length inches (3 digits).
- d = Connection F10, F15, F20, F25, F30, F40, F50, F60, N05, N75, N10, N15, N20 or NAD.
- e = Connection rating A, B, C or D.
- f = Electronics option 0, 1 or 3.
- g = Housing 4, 7, 8 or 9 (4 intrinsically safe and nonincendive only).

HT14abcdefg, HT18abcdefg. Level Transmitter.

- a = Resolution A, D or F.
- b = Wetted parts material S, L, B, C or T.
- c = Sensor length inches (3 digits).
- d = Connection F10, F15, F20, F25, F30, F40, F50, F60, N75, N10, N15, N20 or NAD.
- e = Connection rating A, B, C or D.
- f = Electronics option 0, 1 or 3.
- g = Housing 4, 7, 8 or 9 (4 intrinsically safe and nonincendive only).

HTD14abcdefg, HTD18abcdefg. Level Transmitter.

- a = Resolution A, D or F.
- b = Wetted parts material S, L, B, C or T.
- c = Sensor length inches (3 digits).
- d = Connection F10, F15, F20, F25, F30, F40, F50, F60, N75, N10, N15, N20 or NAD.
- e = Connection rating A, B, C or D.
- f = Electronics option 0 or 1.
- g = Housing 7, 8 or 9.

ST14abcdefg, ST18abcdefg. Level Transmitter.

- a = Resolution A, D or F.
- b = Wetted parts material S or L.
- c = Sensor length inches (3 digits).
- d = Connection 10, 15, 20, 25, 30, 40, 50, 60 or AD.
- e = Connection rating S or N.
- f = Electronics option 0, 1 or 3.

THIS CERTIFICATE MAY ONLY BE REPRODUCED IN ITS ENTIRETY AND WITHOUT CHANGE

FM Approvals LLC, 1151 Boston-Providence Turnpike, Norwood, MA 02062 USA
T: +1 (1) 781 782 4300 F: +1 (1) 781 782 9375 E-mail: information@fmapprovals.com www.fmapprovals.com

SCHEDULE



US Certificate Of Conformity No: FM18US0215

g = Housing 4, 7, 8 or 9 (4 intrinsically safe and nonincendive only).
h = Float stop 1, 2 or 4.

T12abcdefg. Level Transmitter.

a = Resolution A, B, C, D, E, F, G or H.
b = Wetted parts material S, L, C, B or T.
c = Sensor length inches (3 digits).
d = Connection F10, F15, F20, F25, F30, F40, F50, F60, N05, N75, N10, N15, N20 or NAD.
e = Connection rating A, B, C or D.
f = Electronics option 0, 1 or 3.
g = Housing 4, 6, 7, 8 or 9 (4, 6 intrinsically safe and nonincendive only).

T14abcdefg, T18abcdefg. Level Transmitter.

a = Resolution A, B, C, D, E, F, G or H.
b = Wetted parts material S, L, C, B or T.
c = Sensor length inches (3 digits).
d = Connection F10, F15, F20, F25, F30, F40, F50, F60, N75, N10, N15, N20 or NAD.
e = Connection rating A, B, C or D.
f = Electronics option 0, 1 or 3.
g = Housing 4, 6, 7, 8 or 9 (4, 6 intrinsically safe and nonincendive only).

FLR-ab. Level Transmitter.

a = S, Standard (Metal housing)
b = B, Connection housing with Head transmitter

T48abcdefg0. Level Transmitter.

a = Resolution A, B, C, D, E, F, G or H.
b = Wetted parts material S, L, C, B or T.
c = Sensor length inches (3 digits).
d = Connection F20, F25, F30, F40, F50, F60, N20 or NAD.
e = Connection rating A, B, C or D.
f = Electronics option 0, 1 or 3.
g = Housing 4, 6, 7, 8 or 9 (4, 6 intrinsically safe and nonincendive only).

TD14abcdefg, TD18abcdefg. Level Transmitter.

a = Resolution A, B, C, D, E, F, G or H.
b = Wetted parts material S, L, C, B or T.
c = Sensor length inches (3 digits).
d = Connection F10, F15, F20, F25, F30, F40, F50, F60, N75, N10, N15, N20 or NAD.
e = Connection rating A, B, C or D.
f = Electronics option 0 or 1.
g = Housing 7, 8 or 9.

TD48abcdefg0. Level Transmitter.

a = Resolution A, B, C, D, E, F, G or H.
b = Wetted parts material S, L, C, B or T.
c = Sensor length inches (3 digits).
d = Connection F20, F25, F30, F40, F50, F60, N20 or NAD.
e = Connection rating A, B, C or D.
f = Electronics option 0 or 1.
g = Housing 4, 6, 7, 8 or 9 (4, 6 intrinsically safe and nonincendive only).

TP16abcdefg, TP20abcdefg. Level Transmitter.

a = Resolution A, B, C, D, E, F, G or H.
b = Wetted parts material V, P or K.

THIS CERTIFICATE MAY ONLY BE REPRODUCED IN ITS ENTIRETY AND WITHOUT CHANGE

FM Approvals LLC, 1151 Boston-Providence Turnpike, Norwood, MA 02062 USA
T: +1 (1) 781 762 4300 F: +1 (1) 781 762 9375 E-mail: information@fmapprovals.com www.fmapprovals.com

F 347 (Mar 16)

Page 4 of 7

SCHEDULE



US Certificate Of Conformity No: FM18US0215

- c = Sensor length inches (3 digits).
- d = Connection type F10, F15, F20, F25, F30, F40, F50, F60, N75, N10, N15, N20, NAD.
- e = Connection rating A or D.
- f = Electronics option D, 1 or 3.
- g = Housing 1, 4, 7 or 9.

SP12abcdefS and SP20abcdefS. Level Switch.

- a = Number of switches 1, 2, 3 or 4.
- b = Wetted parts material V, P or K.
- c = Sensor length inches (3 digits).
- d = Connection F10, F15, F20, F25, F30, F40, F50, F60, N05 (SP12 only), N10, N15, N20 or NAD.
- e = Connection rating A or D.
- f = Housing 1, 4, 5 or 7.

F50abdefg or F70abdefg. Level Switch.

- a = Number of switches 1, 2, 3 or 4.
- b = Wetted parts material S, L, C, B or T.
- c = Chamber A, B or K.
- d = Connection orientation H or V.
- e = Connection F05, F75, F10, F15, F20, N05, N75 or N10.
- f = Connection rating A, B, C or D.
- g = Housing 4, 5 or 7 (4, 5 nonhazardous location rated).

ELS-ab. Level Switch.

- a = S, Stainless steel
- b = A, Terminal housing / plug > 50V (low voltage)

MRS-2-XP, BGU-AXPFMMS-5-XP or BGU-AMXPF. Level Switch.

MRS-2-XP-HT or BGU-AHTXPF. Level Switch.

S12abdefg. Level Switch.

- a = Number of switches 1, 2, 3 or 4.
- b = Wetted parts material S, L, C, B or T.
- c = Sensor length inches (3 digits).
- d = Connection F10, F15, F20, F25, F30, F40, F50, F60, N05, N75, N10, N15, N20 or NAD.
- e = Connection rating A, B, C or D.
- f = Housing 4, 5, 7 or 8 (4, 5 nonhazardous location rated).
- g = Switch temperature S, L or H.

S18abdefg. Level Switch.

- a = Number of switches 1, 2, 3, 4, 5 or 6.
- b = Wetted parts material S, L, C, B or T.
- c = Sensor length inches (3 digits).
- d = Connection F10, F15, F20, F25, F30, F40, F50, F60, N75, N10, N15, N20 or NAD.
- e = Connection rating A, B, C or D.
- f = Housing 4, 5, 7, 8 or 9 (4, 5 nonhazardous location rated).
- g = Switch temperature S, L or H.

FLS-ab. Level Switch

- a = S, Standard (Metal housing)
- b = B, Connection housing with Head transmitter

S48abdefg. Level Switch.

THIS CERTIFICATE MAY ONLY BE REPRODUCED IN ITS ENTIRETY AND WITHOUT CHANGE

FM Approvals LLC, 1151 Boston-Providence Turnpike, Norwood, MA 02062 USA
T: +1 (1) 781 762 4300 F: +1 (1) 781 782 9375 E-mail: information@fmapprovals.com www.fmapprovals.com

F 347 (Mar 16)

Page 5 of 7

SCHEDULE



US Certificate Of Conformity No: FM18US0215

a = Number of switches 1, 2, 3, 4, 5 or 6 (4 max for S12).
b = Wetted parts material S, L, C, B or T.
c = Sensor length inches (3 digits).
d = Connection F20, F25, F30, F40, F50, F80, N20 or NAD.
e = Connection rating A, B, C or D.
f = Housing 4, 7, 8 or 9 (4 nonhazardous location rated).
g = Switch temperature S, L or H.

SS14abcdefgh. Level Switch.

a = Number of switches 1, 2, 3 or 4.
b = Wetted parts material S or L.
c = Sensor length inches (3 digits).
d = Connection 10, 15, 20, 25, 30, 40, 50, 60 or AD.
e = Connection rating S or N.
f = Housing 4, 7 or 8 (4 nonhazardous location rated).
g = Switch temperature S, L or H.
h = Float stop 1, 2 or 4.

SS18abcdefgh. Level Switch.

a = Number of switches 1, 2, 3, 4, 5 or 6.
b = Wetted parts material S or L.
c = Sensor length inches (3 digits).
d = Connection 10, 15, 20, 25, 30, 40, 50, 60 or AD.
e = Connection rating S or N.
f = Housing 4, 7, 8 or 9 (4 nonhazardous location rated).
g = Switch temperature S, L or H.
h = Float stop 1, 2 or 4.

13. Specific Conditions of Use:

None

14. Test and Assessment Procedure and Conditions:

This Certificate has been issued in accordance with FM Approvals US Certification Requirements.

15. Schedule Drawings

A copy of the technical documentation has been kept by FM Approvals.

16. Certificate History

Details of the supplements to this certificate are described below:

Date	Description
8 th March 1999	Original Issue.

THIS CERTIFICATE MAY ONLY BE REPRODUCED IN ITS ENTIRETY AND WITHOUT CHANGE

FM Approvals LLC, 1151 Boston-Providence Turnpike, Norwood, MA 02062 USA
T: +1 (1) 781 762 4300 F: +1 (1) 781 762 9375 E-mail: information@fmapprovals.com www.fmapprovals.com

F 347 (Mar 16)

Page 6 of 7

SCHEDULE



US Certificate Of Conformity No: FM18US0215

27 th August 2018	<p><u>Supplement 2:</u> Report Reference: – RR214205 dated 27th August 2018. Description of the Change: Company transfer of Project ID 3D4A0.AE listed in this certificate from KSR Kuebler of America to KSR Kuebler Niveau-Messtechnik AG. Standard editions FM3600, FM3615 and FM3810 have been updated as the new standard edition changes are non-technical. Certificate updated to new format.</p>
26 th January 2021	<p><u>Supplement 3:</u> Report Reference: – RR226046 dated 26th January 2021. Description of the Change: Change of company name from KSR KUEBLER Niveau-Messtechnik AG to KSR KUEBLER Niveau-Messtechnik GmbH. Extension of type designation without any technical or design changes. Model ELS-SAF, BGU-AXPF, BGU-AMXPF, BGU-AHTXPF, FLS-SAF Level Switches and BLR-SBF, FLR-SBF Level Transmitters are new codes but are the same design as in the existing approval.</p>

THIS CERTIFICATE MAY ONLY BE REPRODUCED IN ITS ENTIRETY AND WITHOUT CHANGE

FM Approvals LLC, 1151 Boston-Providence Turnpike, Norwood, MA 02062 USA
T: +1 (1) 781 762 4300 F: +1 (1) 781 762 9375 E-mail: information@fmapprovals.com www.fmapprovals.com

F 347 (Mar 16)

Page 7 of 7

For further specifications see data sheet ELS, FLS and LM 30.01.

KSR Kuebler subsidiaries worldwide can be found online at www.ksr-kuebler.com.
WIKA subsidiaries worldwide can be found online at www.wika.com.



KSR Kuebler Niveau-Messtechnik GmbH
Heinrich-Kuebler-Platz 1
69439 Zwingenberg am Neckar • Germany
Tel. +49 6263/87-0
Fax +49 6263/87-99
info@ksr-kuebler.com
www.ksr-kuebler.com



Gayesco-WIKA USA
229 Beltway Green Boulevard
Pasadena, Texas 77503
Tel. +1 713 475 0022
Fax +1 713 475 0011
info@wikahouston.com
www.wika.com